



Building Products

HB&G
 1015 BRUNDIDGE BLVD.
 TROY, AL 36081
 PHONE: 1-800-264-4HBG
 FAX: 1-334-566-4629
 www.hbgcolumns.com

SELECT DESIRED FIBERGLASS COLUMN WITH POLY TUSCAN CAP-BASE SET:

- 980088 - 10" X 8' PLAIN ROUND TAPERED
- 980090 - 10" X 10" X 8' PLAIN SQUARE PULTRUDED

SELECT DESIRED WIND LOAD / DECK PLATES (OPTIONAL):

- ROUND SQUARE

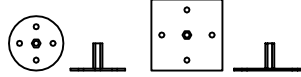

SELECT DESIRED COATING COLOR: (CHROMAGUARD® ENGINEERED COATING)

STANDARD:

- WHITE (INCLUDED)

SEMI-CUSTOM:

- LINEN (917058) ESTATE (917054)
- FOG (917055) MOSS (917059)
- TRICORN (917061) SADDLE (917060)
- CREAM (917053) JAVA (917056)
- LATTE (917057) CANNON (917052)
- COCOA (917062)

SELECT DESIRED OPTION:

- FAN BRACKET (OPTIONAL)

TRANQUILITY™ 20' X 14' FREE STANDING FIBERGLASS PERGOLA	
NO. OF SUPPORT / HEADER BEAMS	4
NO. OF RAFTERS	10
NO. OF PURLINS	12
NO. OF HEADER SUPPORTS	0

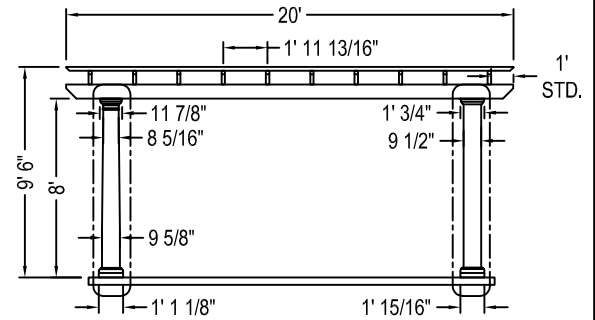

20' X 14' TRANQUILITY™ PERGOLA ROUND COLUMN OPTION

20' X 14' TRANQUILITY™ PERGOLA SQUARE COLUMN OPTION

A FRONT ELEVATION

SELECT DESIRED RAFTER TAIL DESIGN:

STANDARD:

- NAPA (INCLUDED)

SEMI-CUSTOM:

- WINDSOR (917007)
- CRAFTSMAN (917002)
- KENSINGTON (917003)
- SPARTAN (917006)
- ROMAN (917005)
- CONTEMPORARY (917001)

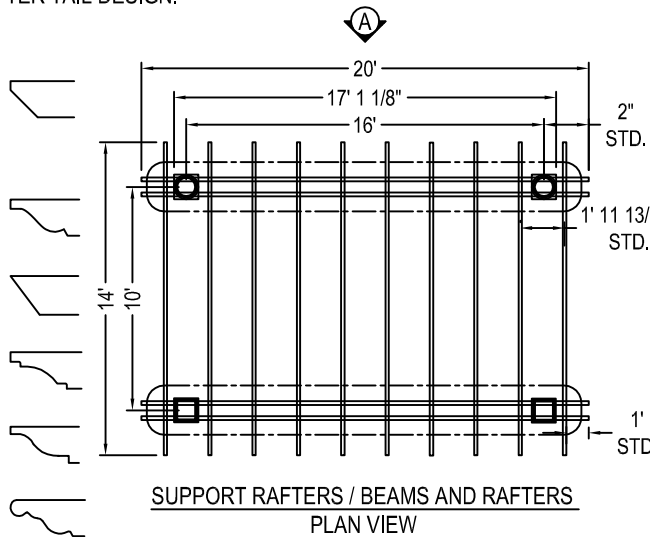

SUPPORT RAFTERS / BEAMS AND RAFTERS PLAN VIEW

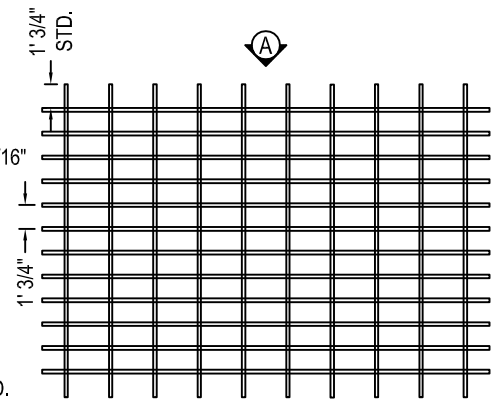

RAFTERS AND PURLINS PLAN VIEW

NOTES:

1. INSTALLATION TO BE COMPLETED IN ACCORDANCE WITH MANUFACTURER'S SPECIFICATIONS WITH INCLUDED ARBOR-LOC® HARDWARE.
2. NOT PRINTED TO SCALE, CAD MODEL 1:1
3. THIS DRAWING IS INTENDED FOR USE BY ARCHITECTS, ENGINEERS, CONTRACTORS, CONSULTANTS AND DESIGN PROFESSIONALS FOR PLANNING PURPOSES ONLY. THIS DRAWING MAY NOT BE USED FOR CONSTRUCTION.
4. ALL INFORMATION CONTAINED HEREIN WAS CURRENT AT THE TIME OF DEVELOPMENT BUT MUST BE REVIEWED AND APPROVED BY THE PRODUCT MANUFACTURER TO BE CONSIDERED ACCURATE.
5. CONTRACTOR'S NOTE: FOR PRODUCT AND COMPANY INFORMATION VISIT www.CADdetails.com/info AND ENTER REFERENCE NUMBER 5118-023

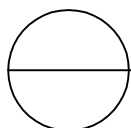

20' X 14' TRANQUILITY™ FREE-STANDING PERGOLAS

TRANQUILITY™ 20' X 14' FREE-STANDING PERGOLA