



Building Products

HB&G
 1015 BRUNDIDGE BLVD.
 TROY, AL 36081
 PHONE: 1-800-264-4HBG
 FAX: 1-334-566-4629
 www.hbgcolumns.com

SELECT DESIRED FIBERGLASS COLUMN WITH POLY TUSCAN CAP-BASE SET:

- 980120 - 10" X 8' PLAIN ROUND TAPERED
- 980122 - 10" X 10" X 8' PLAIN SQUARE PULTRUDED

SELECT DESIRED WIND LOAD / DECK PLATES (OPTIONAL):

- ROUND SQUARE

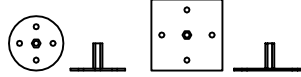

SELECT DESIRED COATING COLOR: (CHROMAGUARD® ENGINEERED COATING)

STANDARD:

- WHITE (INCLUDED)

SEMI-CUSTOM:

- LINEN (917058) ESTATE (917054)
- FOG (917055) MOSS (917059)
- TRICORN (917061) SADDLE (917060)
- CREAM (917053) JAVA (917056)
- LATTE (917057) CANNON (917052)
- COCOA (917062)

SELECT DESIRED OPTION:

- FAN BRACKET (OPTIONAL)

TRANQUILITY™ 22' X 18' FREE STANDING FIBERGLASS PERGOLA	
NO. OF SUPPORT / HEADER BEAMS	4
NO. OF RAFTERS	10
NO. OF PURLINS	16
NO. OF HEADER SUPPORTS	0

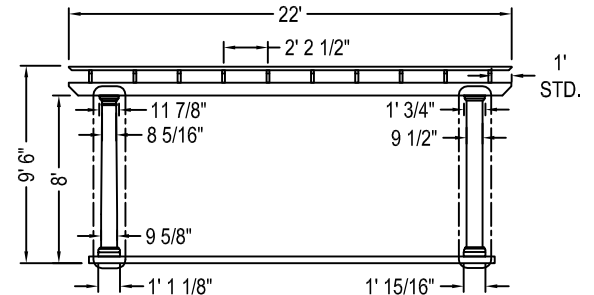

22' X 18' TRANQUILITY™ PERGOLA ROUND COLUMN OPTION

22' X 18' TRANQUILITY™ PERGOLA SQUARE COLUMN OPTION

A FRONT ELEVATION

SELECT DESIRED RAFTER TAIL DESIGN:

STANDARD:

- NAPA (INCLUDED)

SEMI-CUSTOM:

- WINDSOR (917007)
- CRAFTSMAN (917002)
- KENSINGTON (917003)
- SPARTAN (917006)
- ROMAN (917005)
- CONTEMPORARY (917001)

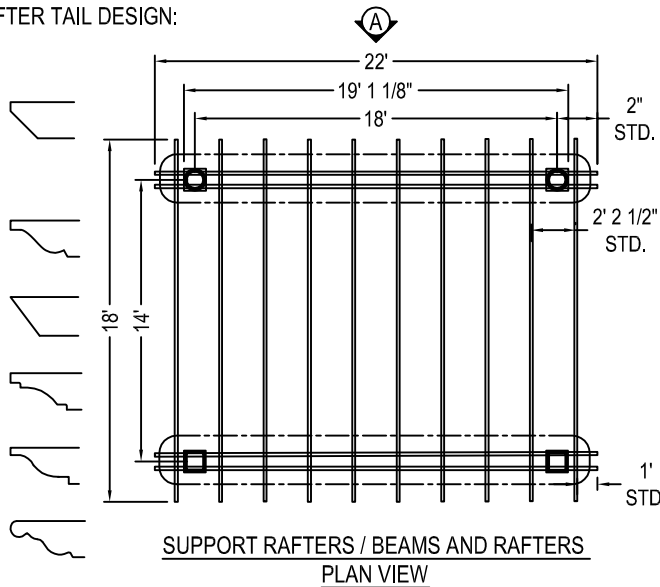

SUPPORT RAFTERS / BEAMS AND RAFTERS PLAN VIEW

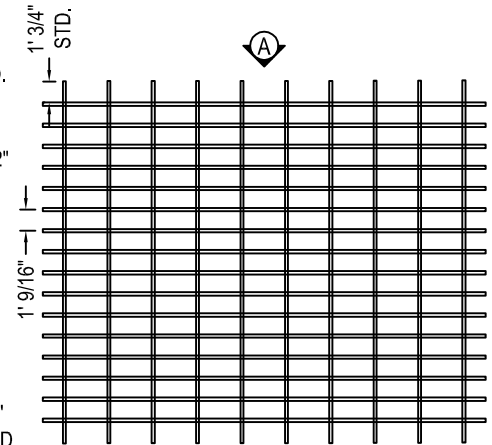

RAFTERS AND PURLINS PLAN VIEW

NOTES:

- INSTALLATION TO BE COMPLETED IN ACCORDANCE WITH MANUFACTURER'S SPECIFICATIONS WITH INCLUDED ARBOR-LOC® HARDWARE.
- NOT PRINTED TO SCALE, CAD MODEL 1:1
- THIS DRAWING IS INTENDED FOR USE BY ARCHITECTS, ENGINEERS, CONTRACTORS, CONSULTANTS AND DESIGN PROFESSIONALS FOR PLANNING PURPOSES ONLY. THIS DRAWING MAY NOT BE USED FOR CONSTRUCTION.
- ALL INFORMATION CONTAINED HEREIN WAS CURRENT AT THE TIME OF DEVELOPMENT BUT MUST BE REVIEWED AND APPROVED BY THE PRODUCT MANUFACTURER TO BE CONSIDERED ACCURATE.
- CONTRACTOR'S NOTE: FOR PRODUCT AND COMPANY INFORMATION VISIT www.CADdetails.com/info AND ENTER REFERENCE NUMBER 5118-031

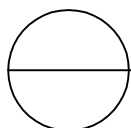

22' X 18' TRANQUILITY™ FREE-STANDING PERGOLAS

TRANQUILITY™ 22' X 18' FREE-STANDING PERGOLA