

# The **HB** **G** PermaRail Plus® Collection

- Available in kits, components, and ready to install pre-built sections
- Prefinished; no painting required
- Compliant with IBC up to 10' and IRC up to 12' (CCRR-0262)
- Newel sleeve fits over a pressure treated 4 x 4 or newel support
- Durable, low maintenance
- Concealed hardware
- Adjustable stair rail brackets\*\*
- Insect and weather proof
- 10/25 Year Limited Warranty\*
- Rail Heights 36" and 42"
- Rail Lengths 6, 8, 10, and 12'
- 1-1/4", and 1-1/2" Square, and Turned Balusters



12" Round PermaCast® with Savannah PermaRail Plus® Railing

\*See Warranty.  
\*\*Patent Pending.

The PermaRail Plus® railing system is a beautiful way to tie your whole porch look together. It is made up of several different components, allowing you the ability to create the designs that match your way of life. Easy to install, this

worry-free railing system will be a beautiful, low maintenance addition to your porch or deck for generations to come. Be sure to use the Coastal Newel Post Mount System in areas where coastal effect corrosion is a concern.

### Savannah

---



### Belhaven

---



### Newport

---



### Standard

---



All rail sections are suitable for use with PermaCast® columns, PermaRail Plus® newels, or PermaPost®.

\*HB&G recommends checking all applicable building code requirements before the design and installation of PermaRail Plus®.

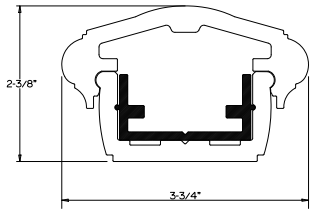

Savannah Top Rail\*

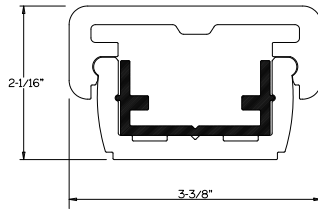

Belhaven Top Rail\*

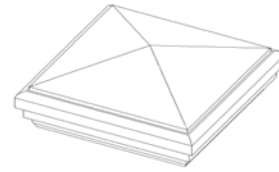

Newel Cap

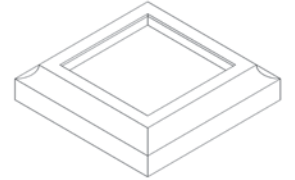

Newel Skirt

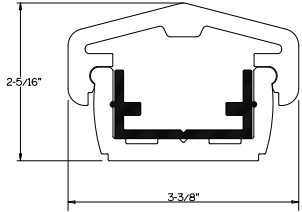

Newport Top Rail\*

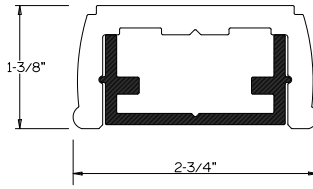

Standard Top Rail\*\* and Standard Bottom Rail with Aluminum Stiffener

\*\*Maximum 8' Length

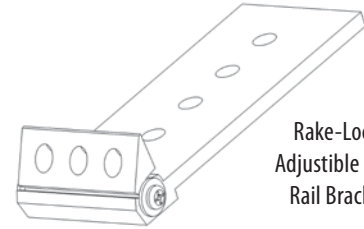

Rake-Loc™ Adjustable Stair Rail Bracket

\*With Aluminum Stiffener and Standard Bottom Rail

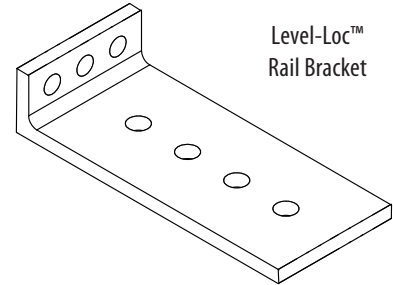

Level-Loc™ Rail Bracket



Supplemental Aluminum Stiffener for Savannah, Newport, and Bellhaven for Rail Lengths over 8'



Standard Aluminum Stiffener

Chesterfield Newel Support Kit

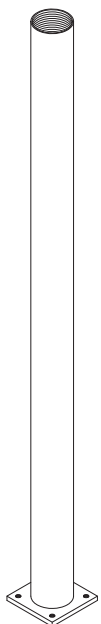

Chesterfield Newel

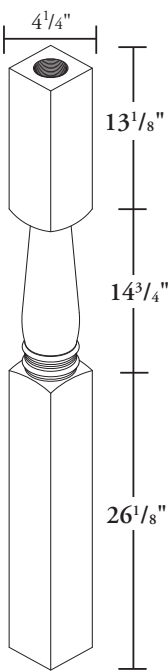

Newel-Loc™ Square Newel Post Mount System\*

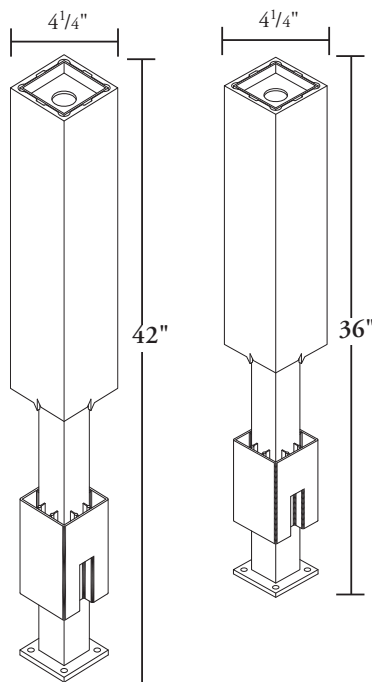

\*The 36" and 42" Newel Post Mount are designed for coastal conditions.

1-1/4" Square Baluster 30" and 36"



1-1/2" Square Baluster 30" and 36"

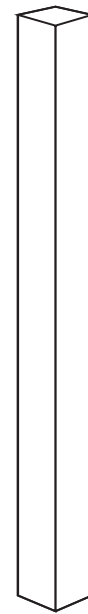

1-1/2" Turned Baluster 30" and 36"

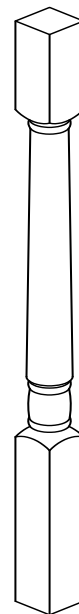

PermaPorch® Newel Sleeve 45" and 54"\*\*\*

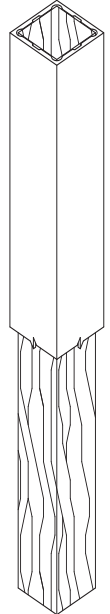

\*\*\*Newel sleeves can be slid over an existing 4 x 4 or installed with the Newel Post Mount.

The top rail, bottom rail, and balusters are pre-finished white. They are made from weather resistant cellular PVC.

# Three Ways to Order the PermaRail Plus® Railing...

## 1. DO-IT-YOURSELF KIT

- Everything needed to assemble and install is included.
  - All standard level rail section components included in one box
  - Balusters and all installation hardware included
- Decorative top rail and Rake-Loc™ stair bracket sold separately
- **HOW TO ORDER:**
  - Choose Your Height: 36" 42"
  - Choose your Length: 6, 8, 10, 12' 6, 8, 10'
  - Choose Decorative Top Rail: Savannah, Newport, Belhaven
  - Note: Standard Rail System has a maximum length of 8'.
  - Optional concealed adjustable stair rail brackets for 6' and 8' rail lengths.
- Kit Includes:
  - Standard top and bottom rail
  - 1 ¼ balusters
  - Support block (s)
  - Aluminum stiffeners
  - Level-Loc™ rail assembly fasteners and installation hardware

## 2. INDIVIDUAL COMPONENTS

- Build your Own Design
- For complete rail system you will need the following:
  - Note: Standard Rail System has a maximum length of 8'
  - Standard top and bottom rail
  - Decorative top rail (if not using the Standard Top Rail\*)
  - Aluminum stiffeners (2) - Supplemental stiffener for rail lengths over 8'
  - 1 ¼ or 1 ½" Balusters – 30" or 36" long
  - Support block(s)
  - Level-Loc™ rail hardware kit
  - Baluster screw kit

## 3. PRE-BUILT SECTIONS

- Shipped factory assembled in standard lengths
- Easy to install
- Everything needed to install included

### HOW TO ORDER:

- Choose Your Height: 36" 42"
- Choose your Length: 6, 8, 10, 12' 6, 8, 10'
- Choose Decorative Top Rail: Savannah, Newport, Belhaven
- Note: Standard Rail System has a maximum length of 8'
- Optional Concealed Adjustable Rake-Loc™ stair rail brackets for 6' and 8' rail lengths
- Onsite trimming and assembly completion required

\*HB&G recommends checking all building codes before the design and installation of your PermaRail Plus® railing.

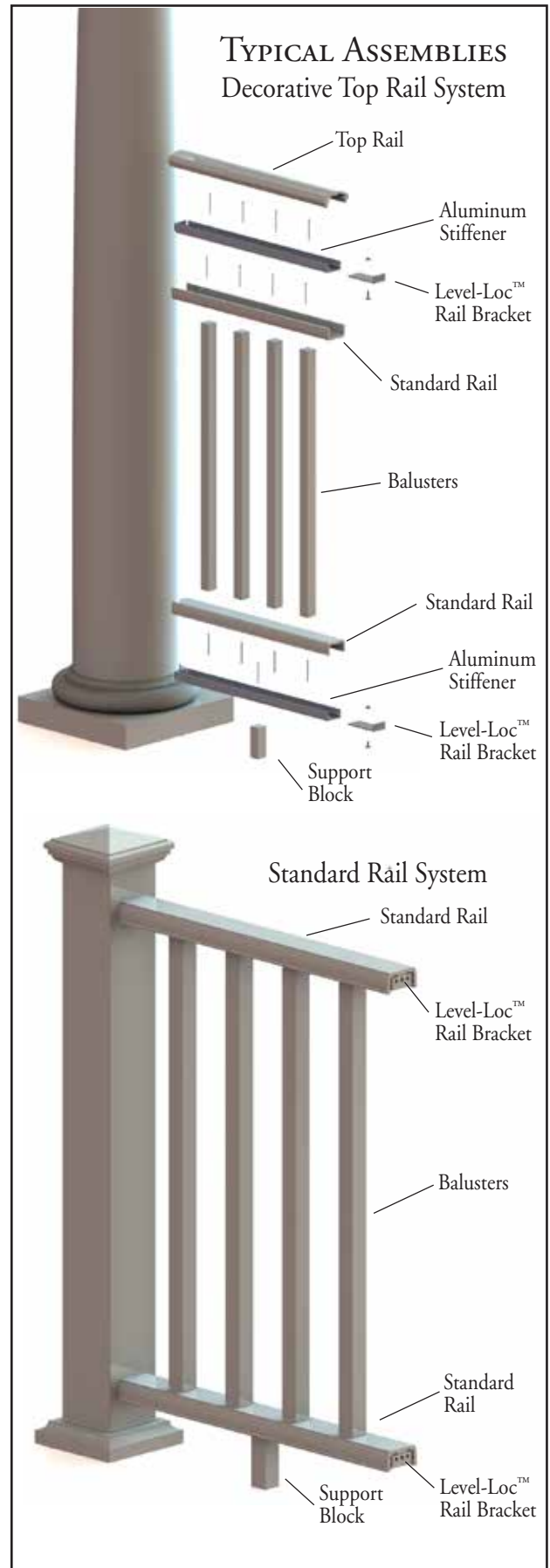

### BUILDING CODE COMPLIANCE

PermaRail Plus® has been tested to the appropriate standards and found to be build code compliant (CCRR-0262) as follows:

Decorative Top Rail System			Standard Top Rail System		
	Level	Rake		Level	Rake
IRC	up to 12'	up to 8'	IRC	up to 8'	up to 8'
IBC	up to 10'	up to 8'	IBC	up to 8'	up to 8'

Review your application to ensure intended use complies with all applicable building codes.