

Balustrade Systems

- Low Maintenance
- Primed White
- Ready to Install and Paint

- Easy Installation
- 25 Year Limited Warranty*



12" Round PermaCast® Columns with Tuscan Cap and Base and 7" Balustrade System

HB&G® has created a unique and elegant balustrade system that can make your home stand out from the rest. These low-maintenance features are made by molding high-density urethane around structural elements in order to provide exceptional beauty,

durability, and quality. Choose from three rail sizes and several baluster profiles. Curved balustrade systems are available in 10' sections. For more information about this exceptional addition to your porch, call 800-264-4HBG (4424).

*See Warranty

6" Balustrade System

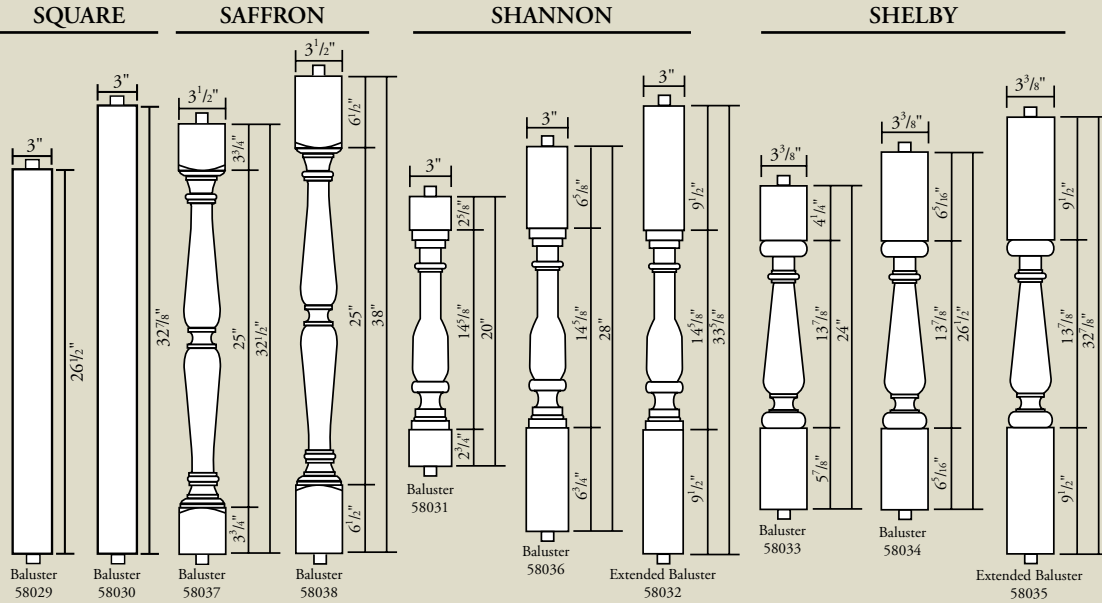

SHERWOOD

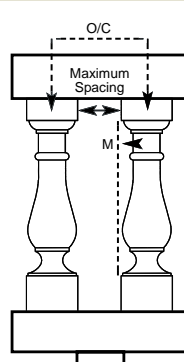
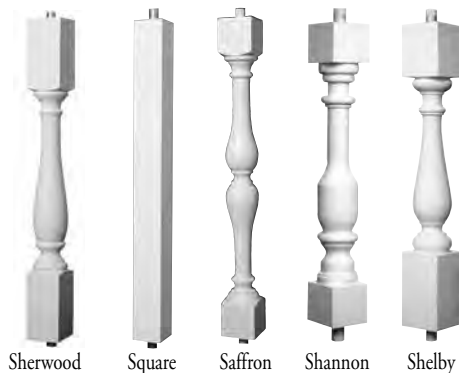
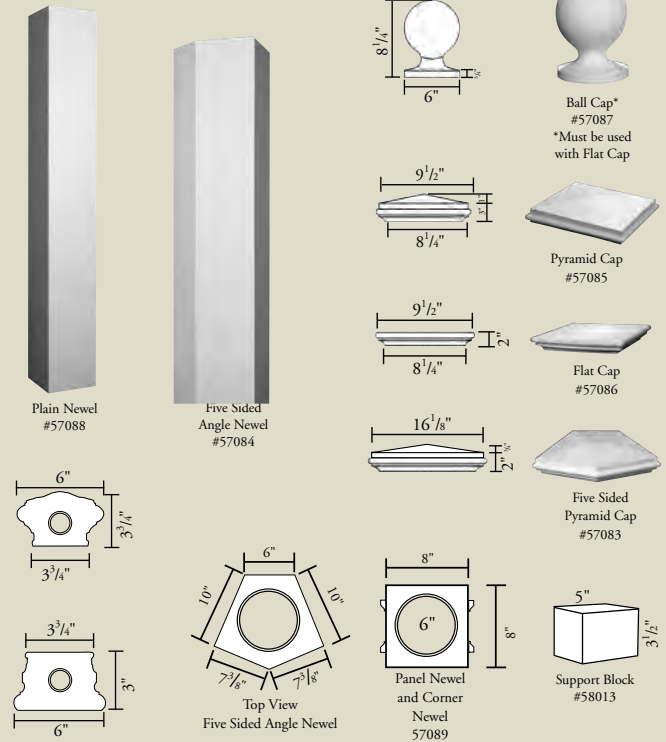
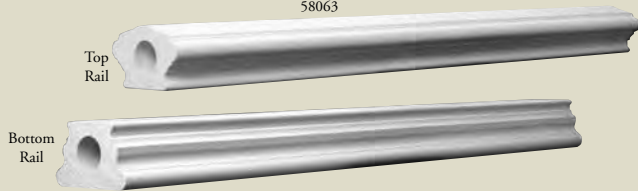
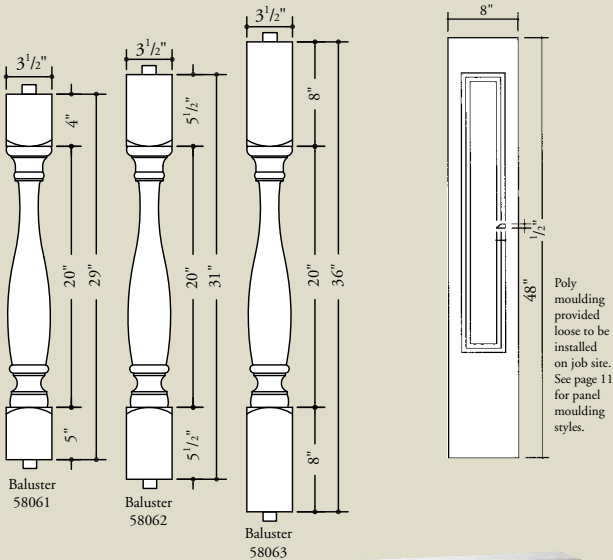

SKU	M	Maximum Spacing	O/C
58031	3/4"	2 1/4"	5 1/4"
58032	3/4"	2 1/4"	5 1/4"
58036	3/4"	2 1/4"	5 1/4"
58033	1"	2 1/8"	5 1/2"
58034	1"	2 1/8"	5 1/2"
58035	1"	2 1/8"	5 1/2"
58037	1"	2"	5 1/2"
58038	1"	2"	5 1/2"
58029	0"	4"	7"
58030	0"	4"	7"
58061	1 1/16"	1 3/4"	5 1/4"
58062	1 1/16"	1 3/4"	5 1/4"
58063	1 1/16"	1 3/4"	5 1/4"

7" Balustrade System

CALVERT

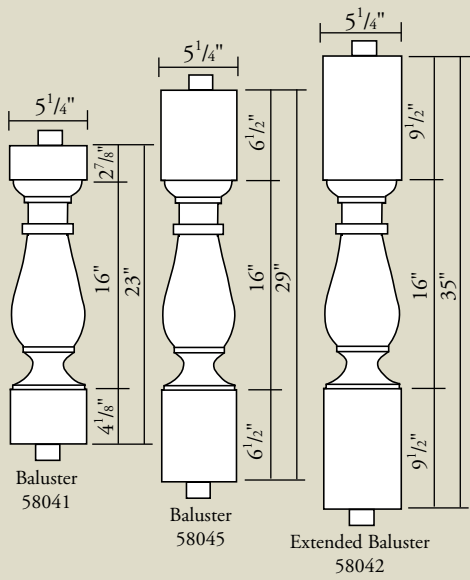

CARRINGTON

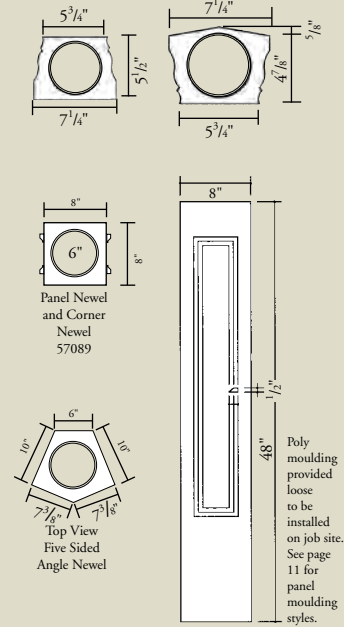
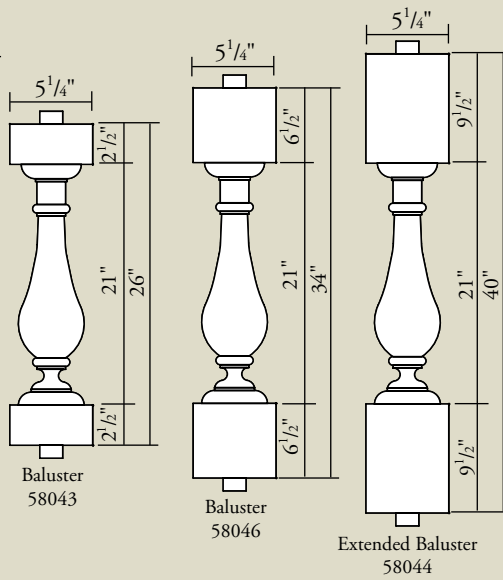

CLEMENT

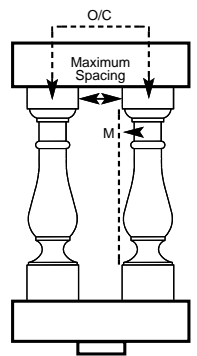
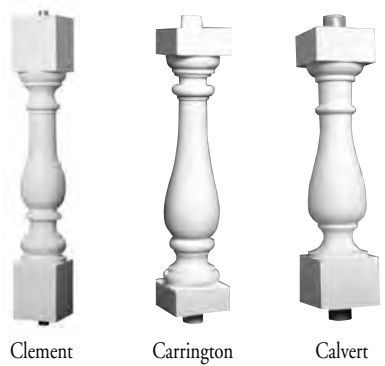
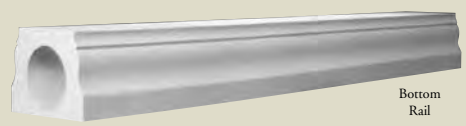
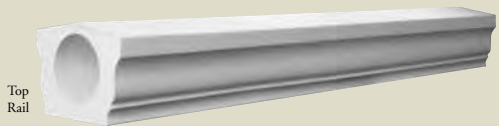
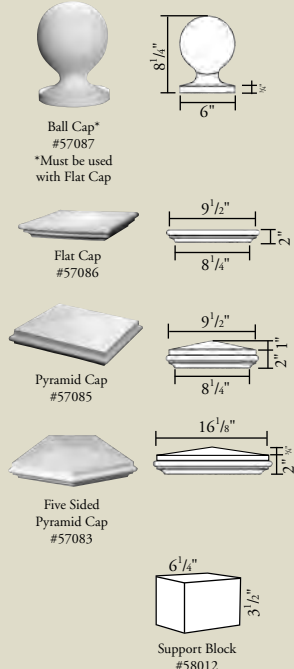
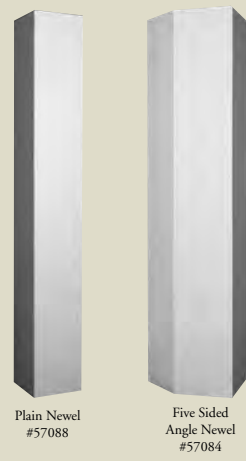
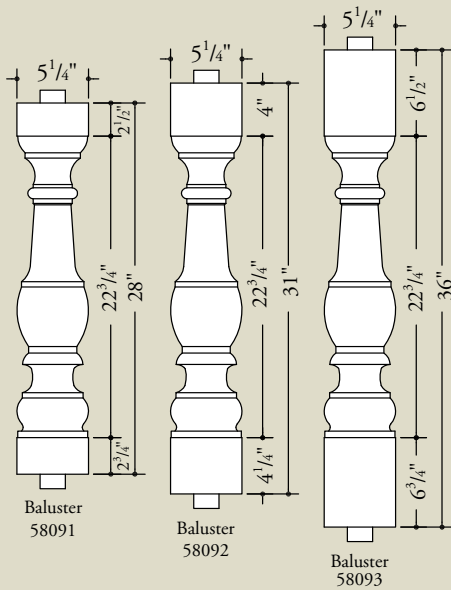

SKU	M	Maximum Spacing	O/C
58041	1-1/4"	1-1/4"	6-1/2"
58042	1-1/4"	1-1/4"	6-1/2"
58045	1-1/4"	1-1/4"	6-1/2"
58043	1-1/2"	3/4"	6"
58044	1-1/2"	3/4"	6"
58046	1-1/2"	3/4"	6"
58091	1-5/16"	1-3/8"	6-5/8"
58092	1-5/16"	1-3/8"	6-5/8"
58093	1-5/16"	1-3/8"	6-5/8"

12" Balustrade System

MANDEVILLE

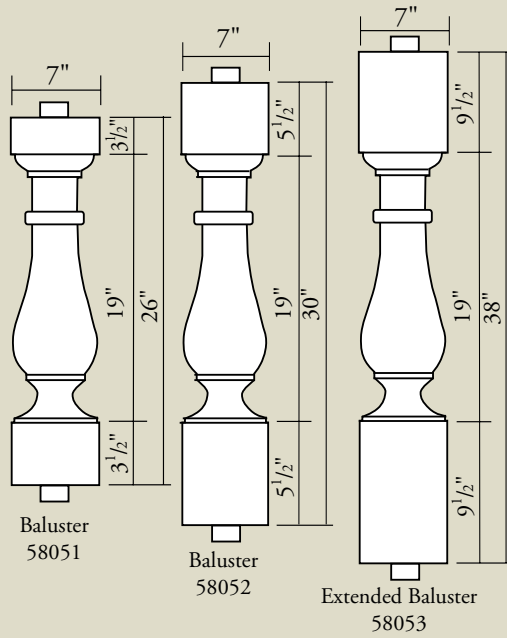

MANASSES

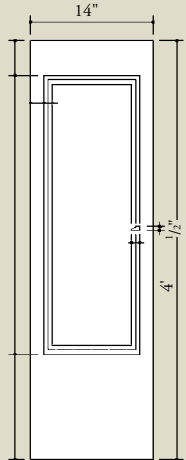
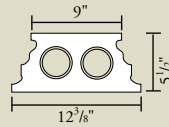
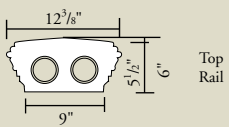
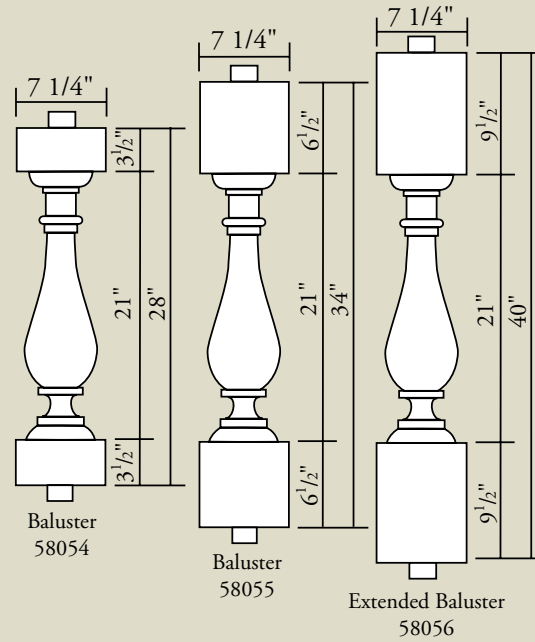

Poly moulding provided loose to be installed on job site. See page 11 for panel moulding styles.

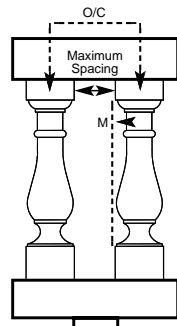
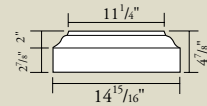
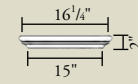
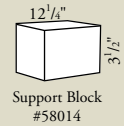
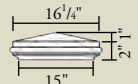
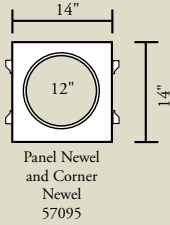

12"

SKU	M	Maximum Spacing	O/C
58051	1-7/8"	3/16"	7-1/8"
58052	1-7/8"	3/16"	7-1/8"
58053	1-7/8"	3/16"	7-1/8"
58054	2-3/8"	0"	7-1/4"
58055	2-3/8"	0"	7-1/4"
58056	2-3/8"	0"	7-1/4"

Curved Balustrade System

- 6", 7", and 12" Rail Styles
- Low Maintenance
- Primed White
- Ready to install and paint
- Easy Installation
- 25 Year Warranty*
- Available in 60"-108" radius
- Modified Radius Available in 6" and 7" systems only

HB&G® Curved Balustrade System will add an elegant finishing touch to any house. Each top and bottom rail style is available in radius from 60" to 108" in 10' lengths. (See pages 41-43 for rail styles.)



*See Warranty

Must purchase balusters and newels separately.

Building Codes

HB&G® recommends checking all local, state, and national building codes before the design and installation of your balustrade system.

HB&G® is not responsible or liable for any balustrade system that does not meet the requirements of the governing building code in the location where the system is installed.

The space between the bottom rail and the substrate should not be less than 2".

TYPICAL ASSEMBLY

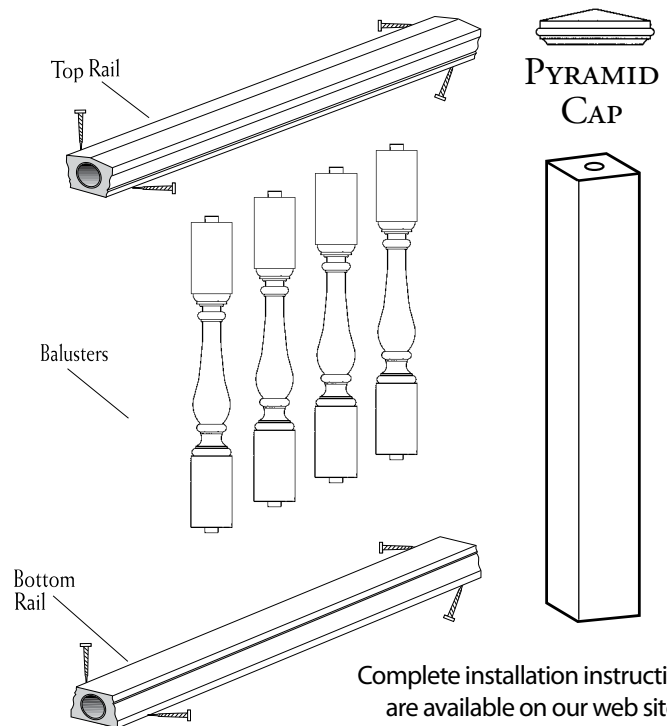

Complete installation instructions are available on our web site or contact us via telephone or email.

NOTE: Rails are not pre-drilled.