

# The PermaPorch® Railing Collection

- Low Maintenance
- Pre-finished or can be painted
- Easy Installation
- As Versatile as Treated Lumber

- Available in Pre-Built Sections
- Deck Options Available
- 10/25 Year Limited Warranty
- Complete Kits Available
- Ready to Install

12" Round PermaCast® Column with Savannah PermaPorch® Railing



The PermaPorch® Railing system is a beautiful way to tie your whole porch look together. It is made up of several different components, allowing you the ability to create the designs that match your way of life. Easy to install, this

worry free railing system will be a beautiful, low maintenance addition to your porch or deck for generations to come. Be sure to use the coastal newel in areas where coastal effect corrosion is a concern.

## Porch Railing

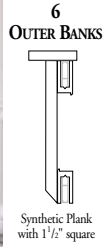
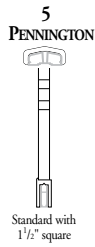
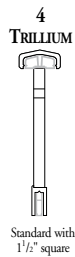
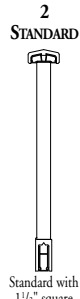
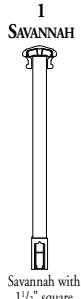

## Deck Railing

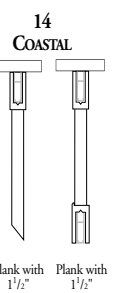
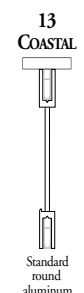
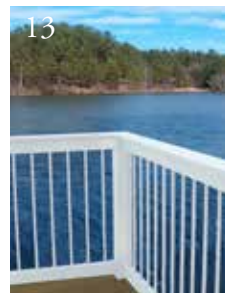
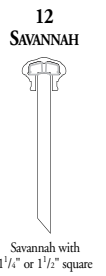
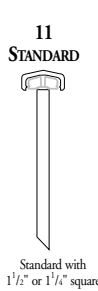
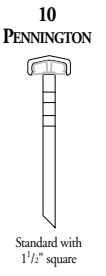
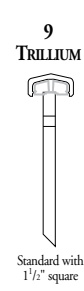
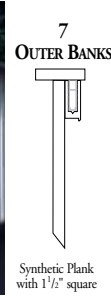

All rail sections suitable with columns (as shown) or PermaPost®  
\* Top Rail Section must be installed on site.

## Pre-Built PermaPorch® Railing

Pre-Built PermaPorch® Railing is available in a variety of styles to match your porch and deck design. The top and bottom rails are made of pre-finished weather resistant cellular PVC with aluminum inserts.

• HB&G recommends checking all building codes before the design and installation of your PermaPorch® Railing.



The top rail, bottom rail, and balusters are available in pre-finished white. They are made from weather resistant cellular PVC. The balusters are also available in round aluminum.

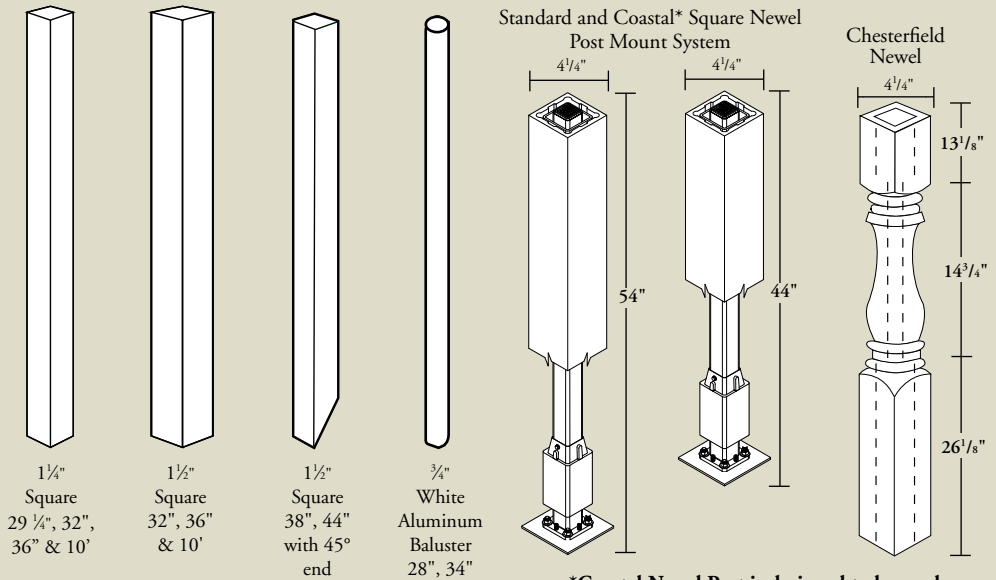
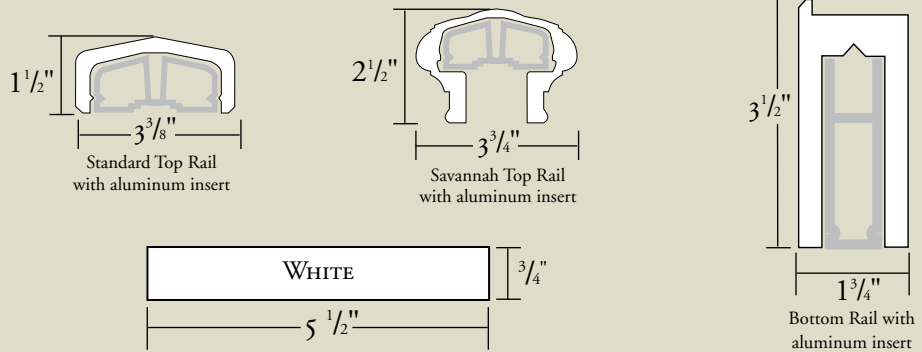

\*Coastal Newel Post is designed to be used in harsh and coastal conditions.

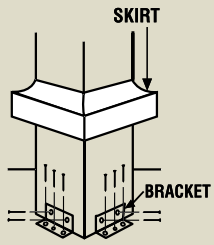

**CHESTERFIELD FASTENING KIT\***

Each kit comes complete with skirt, brackets, and TapCon screws for wood or concrete substrates.

\*Review building code requirements prior to use.



Poly Ball Top  
Height 6"  
Width at Base 4 7/8"

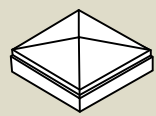

Poly Pyramid Top  
Height 1 1/4"  
Width at Base 4 7/8"

**CUSTOM RAIL PANELS**

Custom rail panels are available. Use our custom rail patterns to create a beautiful, one of a kind look that will set any home apart. HB&G's rail panels are designed to work with the PermaPorch® Railing top and bottom rails. They are made of cellular PVC and can be manufactured using your design or you can choose from one of the styles below. Contact a customer service representative now to order your custom rail panel.

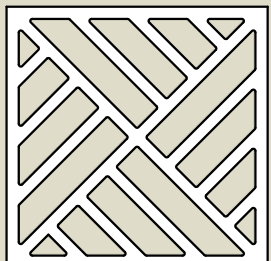

Chippendale

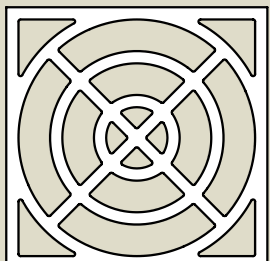

Circle Center

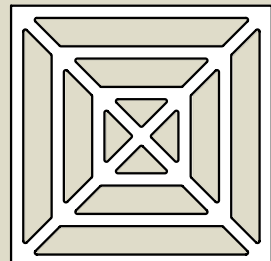

Spiderweb

Savannah PermaPorch® Railing and 5" Square PermaPost®

# Three Ways to Order the PermaPorch® Railing...

## 1. PRE-BUILT SECTIONS

- Shipped factory assembled
- Easy to install
- Everything needed to install is included
- How to order
  - Choose length – 4', 6', or 8' sections
  - Choose desired style from page 33 and 34
  - Note rail height (36" or 42")
- Onsite trimming ensures exact fit

## 2. DO-IT-YOURSELF KIT

- Rail Section shipped in one box
- Balusters are included in box\*
- Everything needed to assemble and install is included
- How to order:
  - Choose length – 6' or 8'
  - Choose style – Savannah or Standard
- Kit includes:
  - Savannah or Standard top rail
  - Bottom rail
  - Aluminum inserts
  - 1 1/2" x 29 1/4" square balusters
    - 8' = 18 balusters
    - 6' = 14 balusters
  - Assembly and installation hardware
  - Support block
- Available in 36" rail height only

\*Screws for balusters are not included

## 3. INDIVIDUAL COMPONENTS

- Build your own design
- Mix and match components
- For a complete rail system you will need the following:
  - Top rail – Standard or Savannah
  - Top insert – aluminum 8', 10', 12'
  - Balusters – 29 1/4", 32", 36", and 10' (Balusters may need to be trimmed for desired rail height.)
  - Bottom rail
  - Bottom insert – aluminum 8', 10', 12'
  - Support block
  - Fastening kit

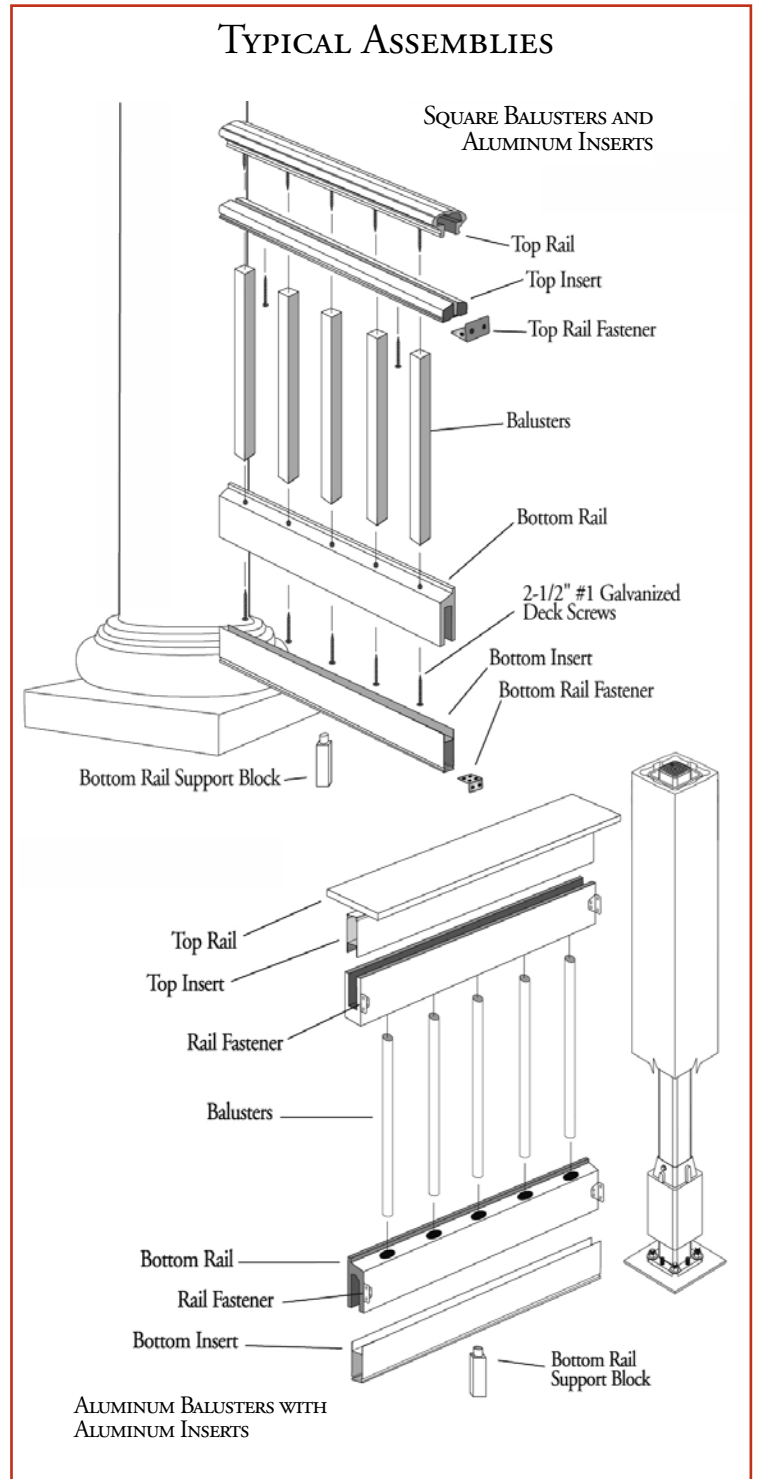

## CURVED PERMAPORCH® RAILING

HB&G has a wide range of PermaPorch® Railing styles and designs. With the curved PermaPorch® Railing, HB&G's line of rail products can meet the needs of any application. The curved PermaPorch® Railing is available with either the Standard or Savannah top rail with wood inserts. Radius from 60" to 240" are available in 8 foot sections. Balusters sold separately. For lead time and ordering info, call 1-800-264-4HBG (4424).

HB&G recommends checking all building codes before the design and installation of your PermaPorch® railing.

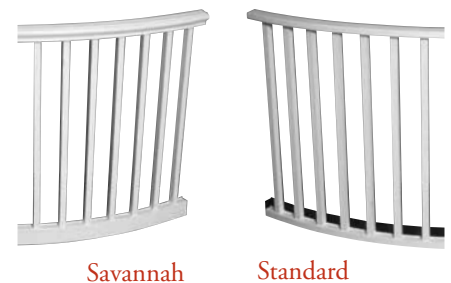

Savannah

Standard