

The **HB** **G** PermaRail Plus™ Collection

- Available in kits, components, and ready to install pre-built sections
- No painting required but can be painted
- Compliant with IBC up to 10' and IRC up to 12' (CCRR-0262)
- Newel sleeve fits over a pressure treated 4" x 4" or newel support
- Durable, low maintenance
- Concealed hardware
- Adjustable stair rail brackets**
- Insect and weather proof
- 10/25 Year Warranty*
- Rail Heights 36" and 42"
- Rail Lengths 6, 8, 10, and 12'



12" Round PermaCast® with Savannah PermaRail Plus™ Railing

12" Round PermaCast® Column with Savannah PermaPorch® Railing

*See Warranty.
**Patent Pending.

The PermaRail Plus™ railing system is a beautiful way to tie your whole porch look together. It is made up of several different components, allowing you the ability to create the designs that match your way of life. Easy to install, this

worry-free railing system will be a beautiful, low maintenance addition to your porch or deck for generations to come. Be sure to use the Coastal Newel Post Mount System in areas where coastal effect corrosion is a concern.

Savannah

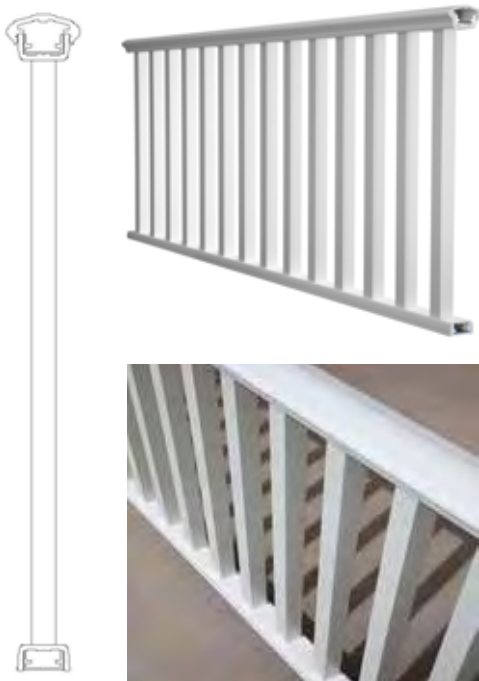

Belhaven



Newport



Standard



All rail sections are suitable for use with PermaCast® columns, PermaRail Plus™ newels, or PermaPost®.

*HB&G recommends checking all applicable building code requirements before the design and installation of PermaRail Plus™.

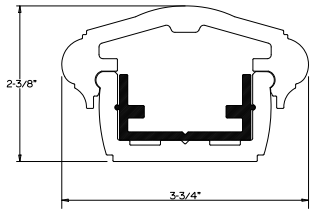

Savannah Top Rail
with Aluminum Stiffener*

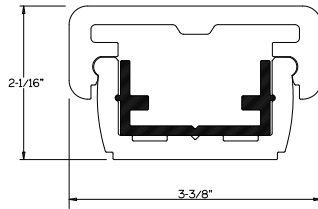

Belhaven Top Rail
with Aluminum Stiffener*

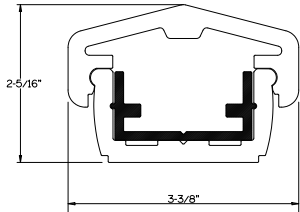

Newport Top Rail
with Aluminum Stiffener*

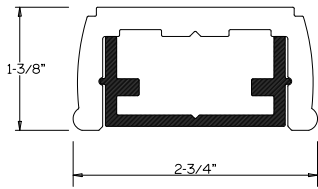

Standard Top Rail** and Universal
Standard Bottom Rail with
Aluminum Stiffener
**Maximum 8' Length



Supplemental Aluminum Stiffener for
Savannah, Newport, and Bellhaven
for Rail Lengths over 8'



Standard Aluminum Stiffener



Newel Cap

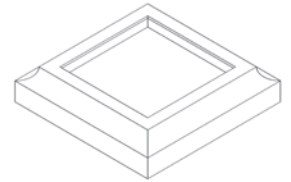

Newel Skirt

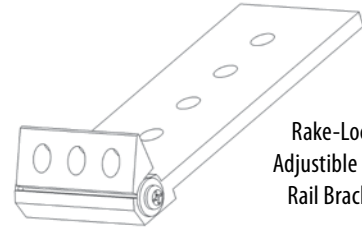

Rake-Loc™
Adjustable Stair
Rail Bracket

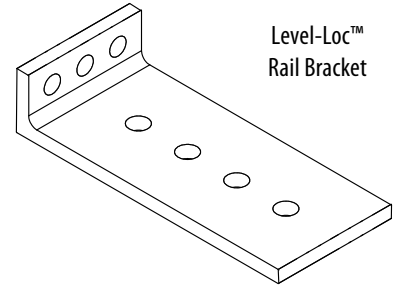

Level-Loc™
Rail Bracket

Newel-Loc™
Standard and Coastal* Square
Newel Post Mount System

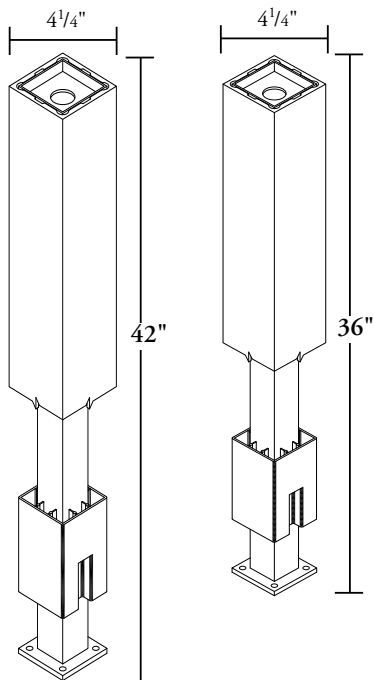

*The 36" and 42" Coastal Newel Post Mount are designed
to be used in harsh and coastal conditions.

Chesterfield
Newel

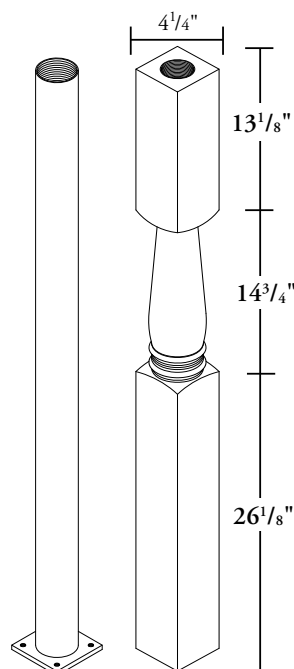

1-1/4" Square
Baluster
30" and 36"

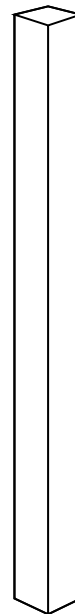

1-1/2" Square
Baluster
30" and 36"

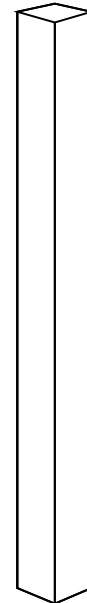

PermaPorch®
Newel Sleeve
45" and 54"***

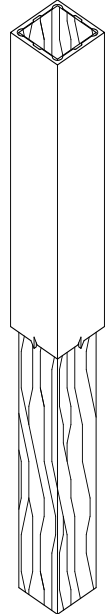

***Newel sleeves can be slid over an existing 4"x4" or
installed system with the Newel Post Mount.
The top rail, bottom rail, and balusters are pre-finished white.
They are made from weather resistant cellular PVC.

Three Ways to Order the PermaRail Plus™ Railing...

1. DO-IT-YOURSELF KIT

- Everything needed to assemble and install is included.
 - All standard rail section components included in one box
 - Balusters and all installation hardware included
- Decorative top rail sold separately
- **HOW TO ORDER:**
 - Choose Your Height: 36" 42"
 - Choose your Length: 6, 8, 10, 12' 6, 8, 10'
 - Choose Decorative Top Rail: Savannah, Newport, Belhaven
 - Note: Standard Rail System has a maximum length of 8'.
 - Optional concealed adjustable stair rail brackets for 6' and 8' rail lengths.
- Kit Includes:
 - Standard top and bottom rail
 - 1 ¼ balusters
 - Support block (s)
 - Aluminum stiffeners
 - Level-Loc™ rail assembly fasteners and installation hardware

2. INDIVIDUAL COMPONENTS

- Build your Own Design
- For complete rail system you will need the following:
 - Note: Standard Rail System has a maximum length of 8'
 - Standard top and bottom rail
 - Decorative top rail (if not using the Standard Top Rail*)
 - Aluminum stiffeners (2)
 - Supplemental stiffener for rail lengths over 8'
 - 1 ¼ or 1 ½" Balusters – 30" or 36" long
 - Support block(s)
 - Level-Loc™ rail hardware kit
 - Baluster screw kit

3. PRE-BUILT SECTIONS

- Shipped factory assembled in standard lengths
- Easy to install
- Everything needed to install included

• HOW TO ORDER:

- Choose Your Height: 36" 42"
 - Choose your Length: 6, 8, 10, 12' 6, 8, 10'
 - Choose Decorative Top Rail: Savannah, Newport, Belhaven
 - Note: Standard Rail System has a maximum length of 8'
 - Optional Concealed Adjustable Rake-Loc™ stair rail brackets for 6' and 8' rail lengths
- Onsite trimming and assembly completion required

*HB&G recommends checking all building codes before the design and installation of your PermaRail Plus™ railing.

